

# RF Power Capacitors Class1

12.7, 20 & 30 mm Barrel Transmitting Types

# RF Power Capacitors Class1

## 12.7, 20 & 30 mm Barrel Transmitting Types

The CeramTec Group is a world leader in the design and manufacture of complex electronic ceramic components and assemblies used in a wide range of applications and cutting edge technologies. CeramTec UK specialises in the development and production of dielectric and ferroelectric materials and components. This range of high voltage RF discs capacitors is fabricated from very low loss CLASS 1 ceramic dielectric materials which permit them to carry very high electrical loads over a wide frequency range.

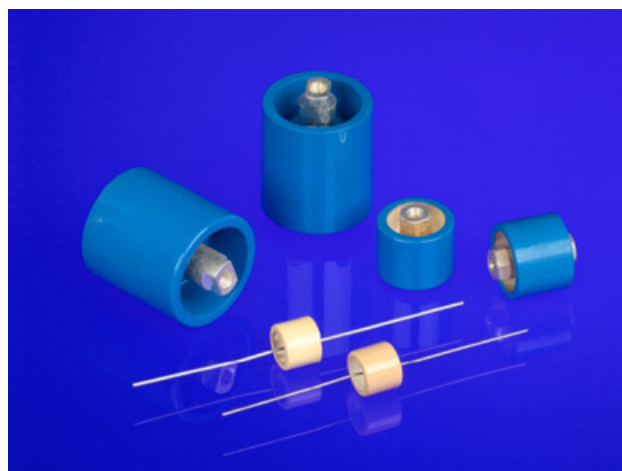

### APPLICATIONS INCLUDE

- Radio Broadcast Transmitters
- Induction and Dielectric Heating Equipment
- HF Filter, By-Pass & Coupling Circuits
- High Power Matching Tuned Circuits
- Antenna Circuits
- Industrial Applications
- High Power matching networks –Plasma Generators
- High quality medical imaging systems (MRI)

### FEATURES

- Low loss Class 1 ceramic dielectric materials with noble metal electrodes resulting in low self heating.
- High Voltage / High Reactive Power Ratings
- Very low NPO capacitance-temperature characteristics available that result in correspondingly low tuned frequency drift.
- Low Inductance construction permitting higher frequency use.
- Low magnetic susceptibility

Material Characteristics							
Dielectric Constant @ 20°C / 1 MHz		15	36	77	90	160	190
Temperature Coefficient of Capacitance	ppm/°C	+100 ±60	0 ±30	0 ±30	-750 ±80	-750 ±120	-1300 ±120
Tan δ 1 MHz (Cap ≤ 1000 pF)	x 10 <sup>-4</sup>	≤ 5	≤ 5	≤ 5	≤ 5	≤ 5	≤ 5
Tan δ 1 kHz (Cap > 1000 pF)	x 10 <sup>-4</sup>	≤ 10	≤ 10	≤ 10	≤ 10	≤ 10	≤ 10
Dielectric Strength	kVmm <sup>-1</sup> dc	22	20	15	10	10	10
Volume Resistivity	Ωm	10 <sup>13</sup>	10 <sup>13</sup>	10 <sup>13</sup>	10 <sup>13</sup>	10 <sup>13</sup>	10 <sup>13</sup>

Electrical Specification	
Capacitance Range	2 – 2500pF (see table)
Capacitance Tolerance	See Tables. Consult factory for other tolerances
Rated RF Voltage	7.5 – 15kV pk (see table)
Test Voltage	1.5 x Rated Voltage / 30sec
RF Voltage, Current & kVA <sub>r</sub> Load v Frequency	See RF rating curves (ref 30°C max ambient temperature)
Operating Temperature Range	-25°C +95°C
Maximum Relative Humidity	75 %

Outline Drawing: 12.7 mm Diameter Wire Leaded

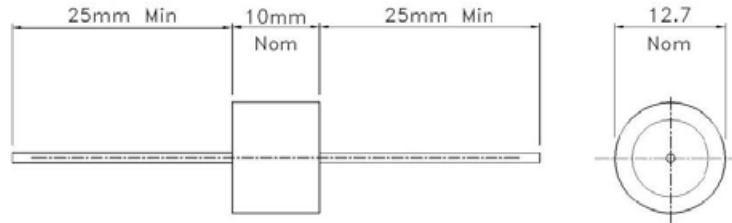

Electrical Characteristics – CLASS 1 Ceramic Discs

Type No	Cap Value pF	TCC ppm/ °C	Rated (ACpk + DC) kVpk	Rated AC kVpk	Test 50 Hz kVrms	Max POWER Rating (kVAR)	Max Current Rating (A rms)
10	2 – 6.5	+100	4	3	4	4	2
11	6.6 – 15	0	4	3	4	4	2
12	15 – 50	-750	4	3	4	4	2
806	50 – 100	-1300	4	3	4	4	2

# RF Power Capacitors Class1

## 12.7, 20 & 30 mm Barrel Transmitting Types

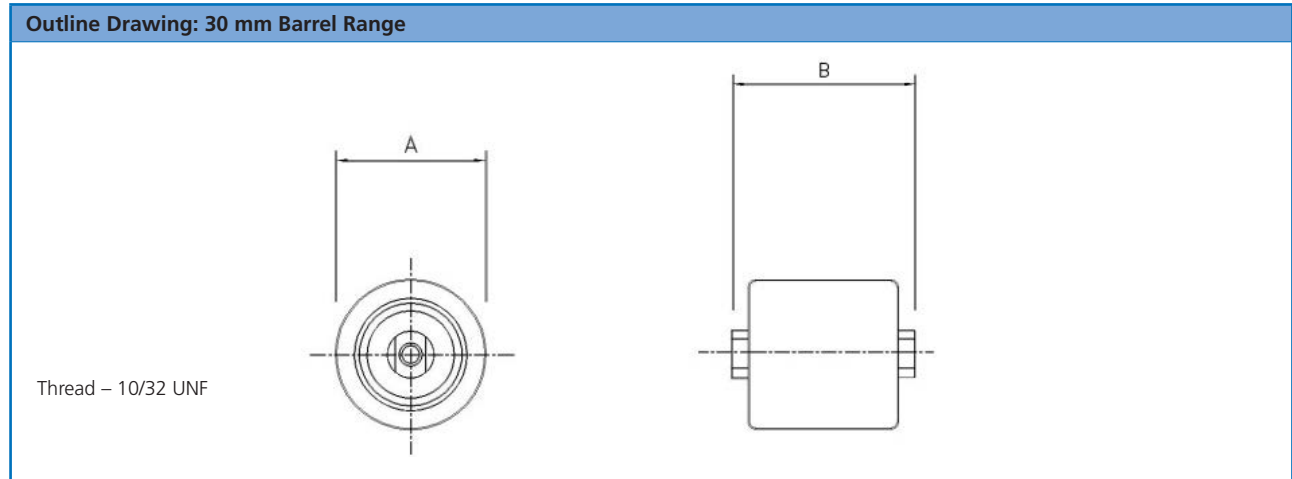

Electrical Characteristics								
Type No	Cap Value pF	TCC ppm/ °C	Cap Tol Min	Rated Voltage kVdc	Max POWER Rating (kVAR)	Max Current Rating (A rms)	A nom (mm)	B nom (mm)
61	5	100+/-60	+/-0.5 pF	15	50	15	31	41.5
61	7	100+/-60	+/-0.5 pF	15	50	15	31	41.5
61	9	100+/-60	+/-0.5 pF	15	50	15	31	40.5
61	10	100+/-60	+/-5 %	15	50	15	31	42.5
61	20	100+/-60	+/-5 %	15	50	15	31	41.5
61	25	0+/-30	+/-5 %	15	50	15	31	43.5
61	33	0+/-30	+/-5 %	15	50	15	31	41
61	40	0+/-30	+/-5 %	15	50	15	31	39.5
61	50	0+/-30	+/-5 %	15	50	15	31	42.5
61	60	0+/-30	+/-5 %	15	50	15	31	41.5
61	75	0+/-30	+/-5 %	10	50	15	31	41
62	75	-750+/-80	+/-5 %	15	35	15	31	40.5
62	83	-750+/-80	+/-5 %	15	35	15	31	40
62	100	-750+/-80	+/-5 %	15	35	15	31	39
62	120	-750+/-120	+/-5 %	15	35	15	31	42
62	150	-750+/-120	+/-5 %	15	35	15	31	40
62	170	-750+/-120	+/-5 %	15	25	15	31	39.5
62	200	-750+/-120	+/-5 %	15	25	15	31	43

# RF POWER CAPACITORS CLASS 1

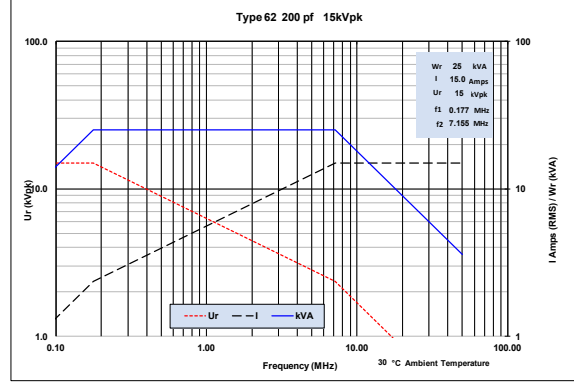
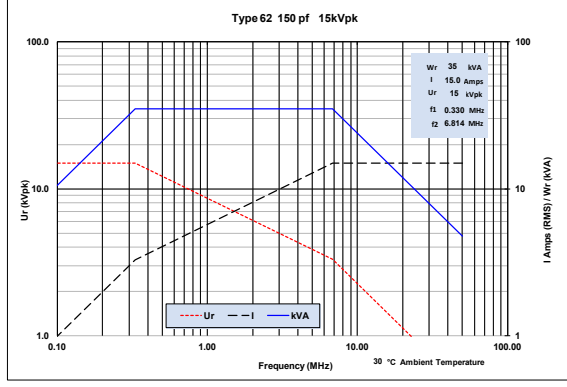
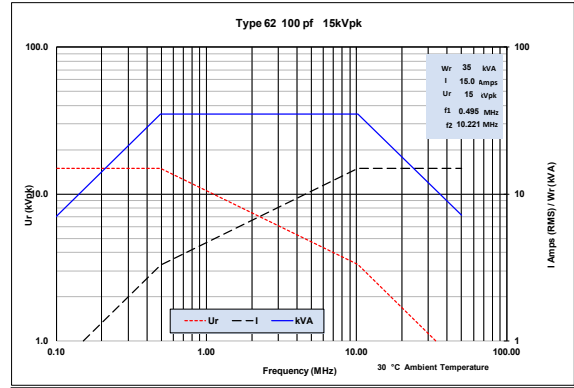
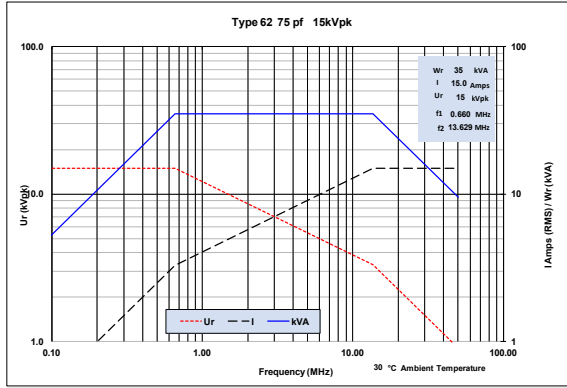
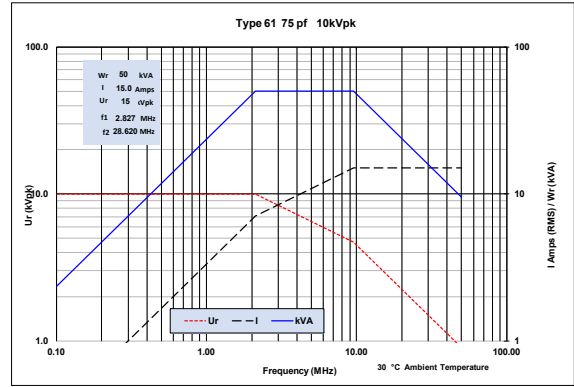
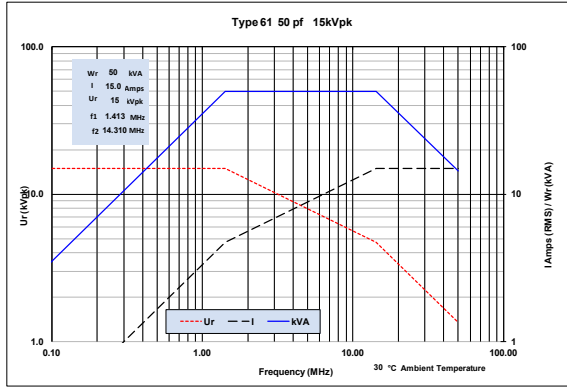
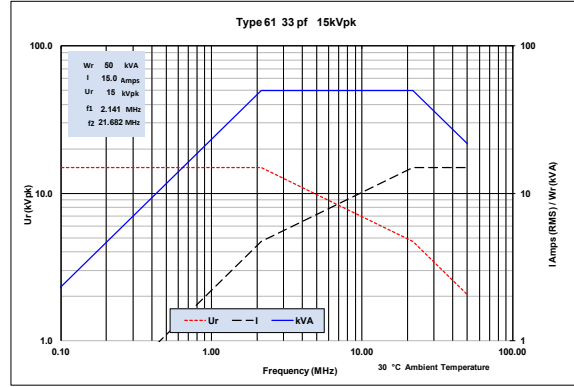
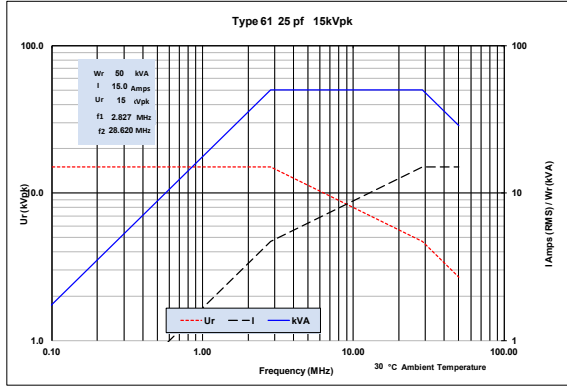

The above RF load conditions are based on the maximum body temperature rise of 45°C from an ambient temperature of 30°C.

# RF Power Capacitors Class1

## 12.7, 20 & 30 mm Barrel Transmitting Types

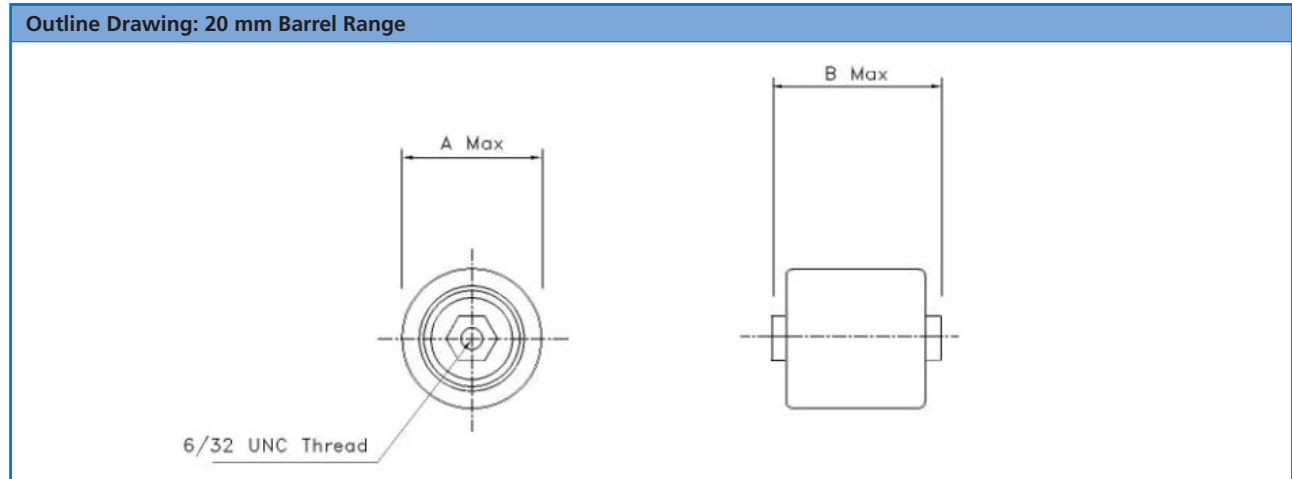

Electrical Characteristics								
Type No	Cap Value pF	TCC ppm/ °C	Cap Tol Min	Rated Voltage kVdc	Max POWER Rating (kVAR)	Max Current Rating (A rms)	A max (mm)	B max (mm)
65	5	100+/-60	+/-0.5 pF	7.5	25	10	20.83	22.61
65	10	100+/-60	+/-5 %	7.5	25	10	20.83	22.61
65	15	0+/-30	+/-5 %	7.5	25	10	20.83	22.61
65	20	0+/-30	+/-5 %	7.5	25	10	20.83	22.61
65	25	0+/-30	+/-5 %	7.5	25	10	20.83	22.61
65	33	0+/-30	+/-5 %	7.5	25	10	20.83	22.61
65	40	0+/-30	+/-5 %	7.5	25	10	20.83	22.61
65	50	0+/-30	+/-5 %	7.5	25	10	20.83	22.61
65	60	0+/-30	+/-5 %	7.5	25	10	20.83	22.61
65	62	0+/-30	+/-5 %	7.5	25	10	20.83	22.61
65	68	0+/-30	+/-5 %	7.5	25	10	20.83	22.61
65	75	0+/-30	+/-5 %	7.5	25	10	20.83	22.61
66	40	-750+ /-80	+/-5 %	7.5	20	10	20.83	22.61
66	50	-750+ /-80	+/-5 %	7.5	20	10	20.83	22.61
66	55	-750+ /-80	+/-5 %	7.5	20	10	20.83	22.61
66	60	-750+ /-80	+/-5 %	7.5	20	10	20.83	22.61
66	65	-750+ /-80	+/-5 %	7.5	20	10	20.83	22.61
66	75	-750+ /-80	+/-5 %	7.5	20	10	20.83	22.61
66	82	-750+ /-80	+ /5 %	7.5	20	10	20.83	22.61
66	100	-750+ /-80	+/-5 %	7.5	20	10	20.83	22.61
66	120	-750+ /-120	+ /5 %	7.5	15	10	20.83	22.61
66	150	-750+ /-120	+/-5 %	7.5	15	10	20.83	22.61
66	170	-750+ /-120	+ /5 %	7.5	15	10	20.83	22.61

# RF POWER CAPACITORS CLASS 1

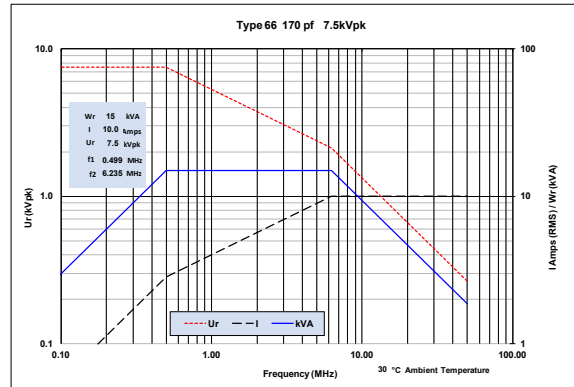
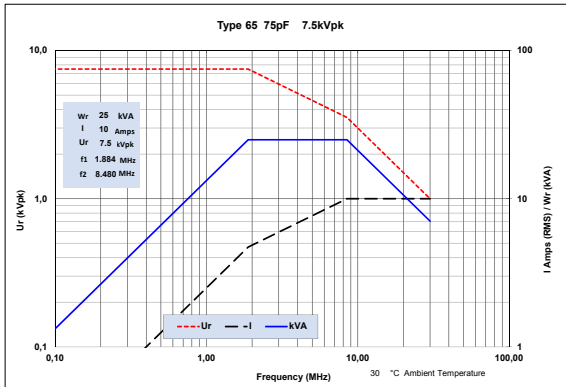
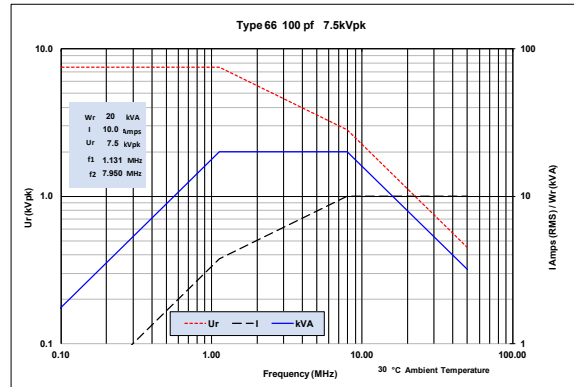
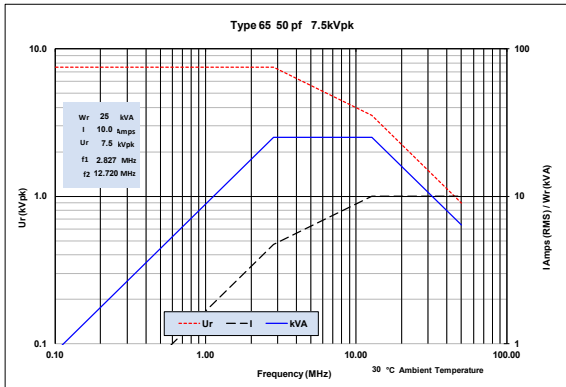
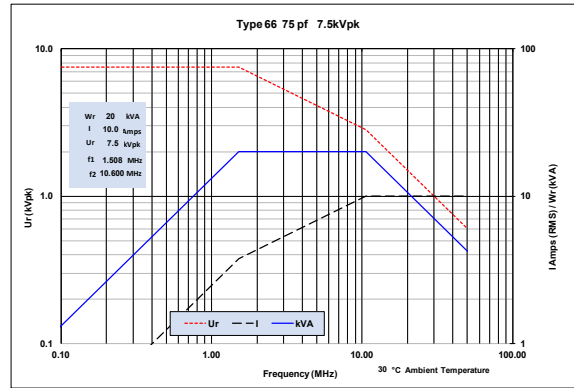
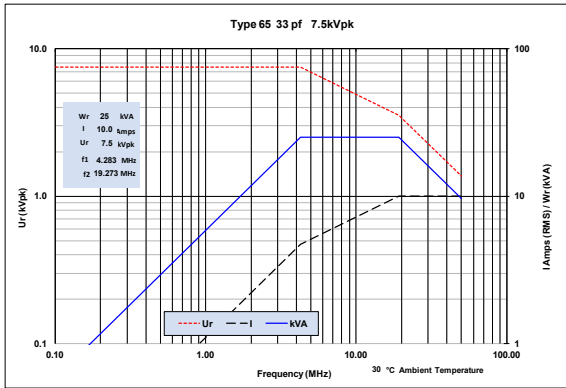
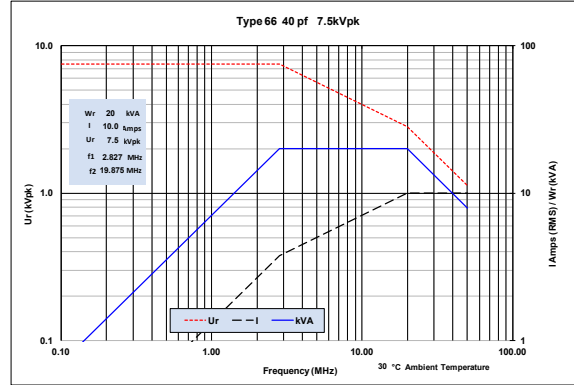
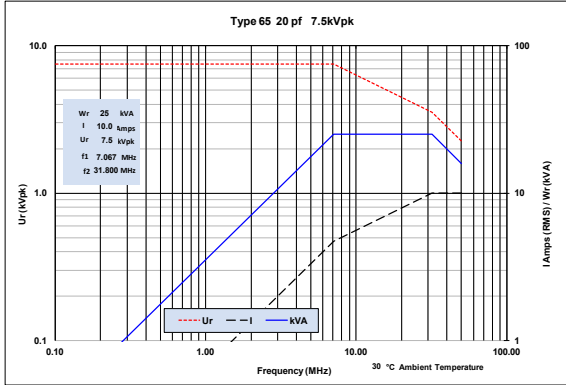

The above RF load conditions are based on the maximum body temperature rise of 45°C from an ambient temperature of 30°C.



The measured values mentioned before were determined for test samples and are applicable as standard values. The values were determined on the basis of DIN-/DIN-VDE standards and if these were not available, on the basis of CeramTec standards. The values indicated must not be transferred to arbitrary formats, components or parts featuring different surface qualities. They do not constitute a guarantee for certain properties. We expressly reserve the right to make technical changes.

**CeramTec UK Limited**  
Vauxhall Industrial Estate  
Ruabon  
Wrexham  
LL14 6HY  
United Kingdom  
Phone +44 (0) 1978 810 456  
[electroceramics@ceramtec.co.uk](mailto:electroceramics@ceramtec.co.uk)  
[www.ceramtec.com](http://www.ceramtec.com)